



2007 OWNER'S MANUAL

Barbecue Grills and Carts

Manufactured after December 1, 2006
© 2007 California Acrylic Industries, Inc.



www.calspas.com

Due to our continuous improvement programs, all models, operation, and/or specifications are subject to change without prior notice.

LTR20071038, Rev. B
1/4/07

**This manual applies to the following
grill carts and drop-in grills:**

Grill Carts	
CR1000	Single burner cart
CR2000	Two burner cart
CR3000	Three burner cart
CR3000S	Three burner cart with side burner
CR4000	Four burner cart
CR4000C	Four burner cart with convection
CR4000S	Four burner cart with side burner
CR4000SC	Four burner cart with side burner and convection
CR5000DS	Five burner cart with double side burners

Drop-In Grills	
BBQ07872	2 Burner Grill
BBQ07873	3 Burner Grill
BBQ07874	4 Burner Grill
BBQ07874C	4 Burner Convection Grill
BBQ07875	5 Burner Grill
BBQ07875C	5 Burner Convection Grill
BBQ07870	Charcoal Grill
BBQ07898	Deluxe Single Side Burner
BBQ07899	Deluxe Double Side Burner
BBQ07874F	4 Burner Flat Drop In Grill
BBQ07852	Drop In Standard Side Burner
BBQ07953	Standard Side-by-Side Burner
BBQ07954	Deluxe Side-by-Side Burner

Copyright 2006-2007 California Acrylic Industries, Inc.
All rights reserved. Duplication without written consent is strictly prohibited.

Cal Spas™ and Cal Flame™ are registered trademarks.

Due to continuous improvement programs, all models, operation, and/or specifications are subject to change without prior notice.

LTR20071038, Rev. B
1/4/07

CONTACT INFORMATION

For customer service, please contact your authorized dealer immediately. If you need additional information and/or assistance, please contact:

C.A.I. Customer Service Department
1462 East Ninth Street
Pomona, CA 91766.

Toll Free: 1-800-CAL-SPAS
Fax: 1-909-629-3890

Read all instructions before you operate your grill.

WARNING

If the information in this manual is not followed exactly, a fire or explosion may result causing property damage, personal injury or loss of life.

Do not store or use gasoline or other flammable vapors and liquids in the vicinity of this or any other appliance.

Do not store an LP cylinder not connected for use in the vicinity of this or any other appliance. A fire resulting in serious injury or death may occur.

If you are installing a natural gas grill, you are responsible for ensuring that the natural gas line installed is safe to use. California Acrylics Industries (C.A.I.) will not be held responsible for an improperly installed gas line.

DANGER

What To Do If You Smell Gas

- Shut off gas to the appliance.
- Extinguish any open flame.
- Open lid.
- If odor continues, keep away from the appliance and immediately call your gas supplier or your fire department.

Safety Instructions 2

Installation / Assembly 4

 Cabinet Cut-out Dimensions 4

 Gas Requirements and Connection 7

 Leak Testing Procedure 7

 LP Gas 8

 Natural Gas 9

 Installing and Replacing Infrared Burners . . . 10

 Installing the Transformer 11

 Installing Grills in Modular Carts 12

 Installing Grills in Barbecue Islands 12

 Installing Barbecue Cart End Shelves 13

 Installing the Rotisserie 13

 Installing Side Burners 14

Operating Your Barbecue 15

 Grill Controls 15

 Lighting the Grill 16

 Basic Grill Operation 17

 Cooking with the Rotisserie 17

 Cooking with a Convection Grill 18

 Charcoal Grill 19

 Turning on and off the Lights and Fan 19

 Griddle 20

 Drop-In Food Warmer 20

 30" Warming Drawer 20

Cleaning and Maintenance 22

 Drip Pan 22

 Care of Stainless Steel 22

 Covering Your Cart or Grill 22

 After Use Care 22

 Griddle 23

 Charcoal Grill 23

 Drop-in Food Warmer 23

 30" Food Warmer 23

 Light Bulb Replacement 24

Appendix 25

 Troubleshooting 25

 Replacement Covers 27

 Location of Serial Number Plate 27

 Warranty Information 30

Save these instructions!

Safety Instructions

Safety Instructions

WARNING: Improper installation, adjustment, alteration, service or maintenance can cause injury or property damage. Read the installation, operating and maintenance instructions thoroughly before installing or servicing this equipment.

Placement and Location

- **Cal Flame™ grills and carts are designed for outdoor use only.**
- Never locate this appliance in an enclosed room, under a sealed overhead structure, or in any type of enclosed area such as a garage, shed, or breezeway. Keep clear of trees and shrubs.
- Do not place this grill under or near windows or vents that can be opened into your home.
- Cal Flame™ grills are not intended for installation in or on recreational vehicles or boats.
- Maintain sufficient distance as to not overheat any overhead combustible material such as a patio cover.
- The area surrounding your new grill should be kept clean and free from flammable liquids and other combustible materials such as mops, rags or brooms, as well as solvents, cleaning fluids, and gasoline.
- Do not use the grill, grill cabinet, or area surrounding the grill as a storage area for flammable or plastic items. Do not store the liquid propane (LP) cylinder in the vicinity of this or any other appliance when it is not being used.

Set-Up

- Before installing built in grills in enclosures, copy all product information such as model number, serial number and type of grill (e.g. natural gas or LP) and store information in a safe place. This information is located on a plate located behind the grill and is visible when the hood is lowered or on the right side of the chassis. There is an area on the back cover of this manual where you can write down this information.
- We recommend that a licensed contractor install your Cal Flame™ grill. Installation must conform to local codes, or in the absence of local codes, with either the *National Fuel Gas Code*, ANSI Z223.1 / NFPA54, *Natural Gas and Propane Installation Code*, CSA B149.1, or *Propane Storage and Handling Code*, B149.2), as applicable.
- Your Cal Flame™ grill or cart must be plugged into a permanent, grounded 110V outlet with a

dedicated 15A GFCI breaker in accordance with local codes or the *National Electrical Code*, ANSI / NFPA 70, or the *Canadian Electrical Code*, CSA C22.1.

- Do not use an extension cord to supply power to your Cal Flame™ grill or cart. Such use may result in fire, electrical shock or other personal injury. Do not install a fuse in the neutral or ground circuit. A fuse in the neutral or ground circuit may result in an electrical shock hazard. Do not ground this appliance to a gas supply pipe or hot water pipe. Keep any electrical supply cords and the fuel supply hose away from any heated surfaces.
- To prevent fire and smoke damage, remove all packaging material before operating grill.
- Before you start cooking, clean the entire grill thoroughly with hot, soapy water. This is necessary to remove residual solvents, oil and grease used in the manufacturing process. The grates should also be thoroughly cleaned in the same manner.

Operation

- Do not use grill for other than intended use.
- In the event that a burner goes out, turn burner knobs to the full OFF position, fully open the grill hood and let it air out. Do not attempt to use the grill until the gas has had time to dissipate.
- Never use the grill if the drip pan is not properly installed. Drip pan should be pushed all the way to the rack located just under the grill. Fire or explosion can result from an improperly installed drip pan.
- Keep all electrical supply cords and the rotisserie motor cord away from the heated areas of the grill.
- Never use the grill or side burner in windy conditions. If used in a consistently windy area a windbreak will be required. Always adhere to the specified clearances listed in this manual.
- Never line the grill or side burners with aluminum foil.
- When the unit is not in use, be sure to turn off the gas at the LP tank.
- Do not install or operate your grill unit in such a manner that the cross ventilation openings are

blocked. Fresh air must be able to pass through installed vents to safeguard against residual gas accumulation. Failure to allow proper ventilation may cause fire or explosion.

- When handling LP gas line and connectors, do not allow them to come in contact with any metal surfaces of the cart or cabinet. Do not drop LP connectors.
- Do not use fuel such as charcoal briquettes in electric or gas grills
- Gas sources to the grill and side burners must be regulated. Do not operate grill or side burners if regulators have been removed, fire or explosion can occur.
- Never leave the grill and side burners unattended when in use. When using pots and pans, boil-overs will cause smoking and greasy boil-overs may ignite.
- Always use the proper size pan. Select utensils with flat bottoms large enough to cover the burner. The use of under-sized utensils exposes the sides of the utensils to direct contact with a portion of the flame. This can scorch utensils and hamper cleanup. Excessive flames on large stainless steel pots can result in permanent discoloration. For best results, we recommend commercial quality aluminum pans and utensils.
- Always position handles of utensils so they do not extend over adjacent work areas or cooking areas. This reduces the risk of burns, ignition of flammable materials, and spillage due to accidental contact with the utensils.
- Do not use water on grease fires. Never pick up a flaming pan. Turn the appliance off and smother the flaming pan with a tight-fitting lid, a cookie sheet or a flat tray. For flaming grease outside of the pan, smother it with baking soda or use a dry chemical or foam-type fire extinguisher.
- Never allow clothing, pot holders or other flammable materials come in contact with or be close to any grate, burner or hot surface until it has fully cooled. Never wear loose fitting or hanging garments while using your grill. Fabric may ignite and result in personal injury.
- When using the grill, do not touch the grill rack, burner grate, or immediate surroundings as these areas become extremely hot and can cause burns. Use handles or knobs.
- Only use dry pot holders and do not use a towel or other bulky cloth in place of pot holders. Moist or damp pot holders used on hot surfaces can cause burns.

- Do not heat any unopened glass or metal container of food on the grill. Pressure may build up and cause the container to burst, possibly resulting in serious personal injury or damage to the grill.
- Do not reach over your grill or any other surfaces when hot or in use.

Maintenance and Repair

- Spiders and other insects can nest in the burners of the grill and block the gas and airflow to the burner ports. This creates a dangerous condition that can result in a fire behind the valve panel. Inspect and clean the burners periodically and follow the guidelines in the Cleaning and Maintenance section of this manual.
- Unless specifically recommended in this manual, do not repair or replace any part of the grill. A qualified technician should perform all service. Any repairs made by a non- C.A.I. approved dealer technician will void your warranty.

Storage

- When your gas grill is not in use, turn off the gas at the supply cylinder.
- Storage of a grill or cart indoors is permissible only if the supply cylinder is disconnected and removed.

Precautions Regarding Children

- Never leave children unattended in the area where the grill is being used. Close supervision of children is necessary when any appliance is used near children.
- Do not store items of interest to children around or below the grill or cart.
- Never allow children to sit or stand on any part of the grill or cart.

Carts

- Do not attempt to move the stainless steel cart while it is hot or in use.
- It is extremely important to lock all caster wheels even on flat surfaces.
- Do not lean, sit or stand on the stainless steel cart, including the foldout work surfaces.
- Do not exceed 50 pounds of weight on the foldout work surfaces.

Installation / Assembly

Most cities and counties require permits for exterior construction and electrical circuits. In addition, some communities have codes requiring residential barriers such as fencing and/or self-closing gates on property to prevent unsupervised access to the property by children under the age of five. Your dealer can provide information on which permits may be required and how to obtain them prior to the delivery of your equipment.

We recommend the installation, adjustment and service of your new grill be performed by C.A.I. qualified installers and service technicians to ensure proper operation and prevent accidents.

When planning your Cal Flame™ grill or cart location, access to gas lines and 110V power supplies should be considered. The location with the shortest gas line run is recommended. A grounded, dedicated, 15A, 110V, GFCI power source is required for use of your appliances (e.g. lights, rotisserie, refrigerator, receptacles, etc.).

When determining a suitable location, consider factors such as exposure to wind, proximity to traffic paths, and windows that open into the home.

Locate barbecue grills and stainless steel carts only in well-ventilated areas and only on solid, flat foundations (e.g. deck or cement slab). Do NOT place stainless steel carts on dirt or grass.

Cabinet Cut-out Dimensions

Your Cal Flame™ grill is designed for easy installation into a non-combustible enclosure. The supporting deck or counter must be flat and level. When determining the final location of your grill, adequate cross ventilation must be present to prevent gas from being trapped in the event of a leak.

The drawings below show the different types of cabinet cut-out dimensions for gas grills and accessories.

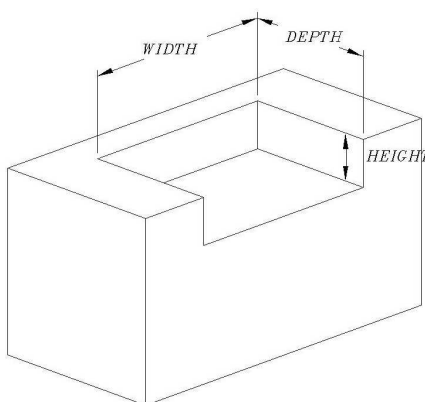
Model Number	Description	Width	Depth	Height	Cut-out for barbecues, side burners and slide-in accessories
BBQ07870P / CP	Charcoal Grill	30 ¾"	22 ¼"	9 ¼"	
BBQ07872-1P	2 Burner Grill	23 ¼"	22 ¼"	9 ¼"	
BBQ873	3 Burner Grill	23 ¼"	22 ¼"	9 ¼"	
BBQ07874-1P	4 Burner Grill	30 ¾"	22 ¼"	9 ¼"	
BBQ07875-1P	5 Burner Grill	38 ¼"	22 ¼"	9 ¼"	
BBQ07875SP	5 Burner SmartControl Grill	38 ¼"	22 ¼"	Center open	
BBQ07898P	Deluxe Single Side Burner	12 1/8"	21 ¾"	7 ¼"	
BBQ07899P	Deluxe Double Side Burner	12 3/8"	21 ¾"	7 ¼"	
BBQ07954	Deluxe Side by Side Burner	25 ¼"	13 ¼"	7 ¼"	
BBQ07864P	Ice Chest	31"	22 ½"	8 ¾"	
BBQ07888P	Food Warmer	12 ½"	20 ½"	7"	
BBQ07842P-12	12" Cocktail Center	12 ¼"	21 ¾"	7"	
BBQ07842P-18	18" Cocktail Center	17 ½"	24 3/8"	10"	
BBQ07902	30" Drop-in Bar Center	28 ¾"	22 ¾"	12"	
BBQ07903	Standard Blender	16 ½"	24 3/4"	11 ¼"	
BBQ07877P	Pizza Oven	17 1/2"	23 ¼"	9 1/2"	

Installation / Assembly

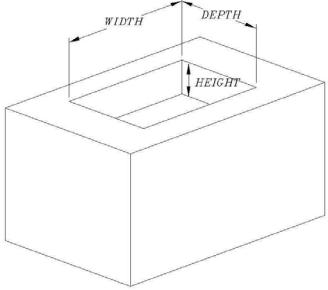
Model Number	Description	Width	Depth	Height	Cut-out for drop in accessories
BBQ07852P	Drop In Standard Side Burner	11 ½"	17 ¾"	2 ¾"	
BBQ07845P	Drop In Sink	14 ½"	14 ½"		
BBQ07953P	Standard Side by Side Burner	24 ¼"	19 ¾"	4 ¼"	

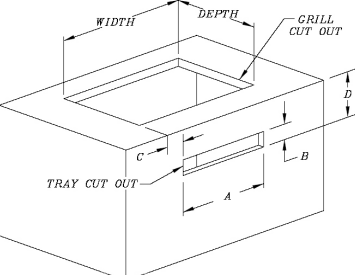
Model Number	Description	Width	Depth	Height	Cut-out for flat drop-in grill and drip tray	
BBQ07874-F1	4 Burner Flat Drop In Grill	37 ¾"	22 ¾"	8 ¾"		
		A	B	C		D
BBQ0704103031	Drip tray cut-out	21 ¾"	1 ¾"	5"		6 ½"

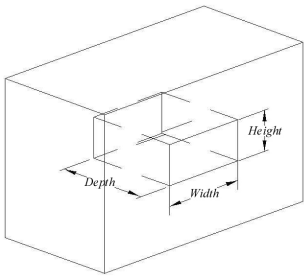
Model Number	Description	Width	Depth	Height	Cut-out for drawers
BBQ07868P	2 Drawer Storage	10 ¾"	19 ¾"	17 ¼"	
BBQ07869P	3 Drawer Storage	10 ¾"	20"	17 ¼"	
BBQ07862P	Griddle and Griddle Storage	13 ½"	19"	2 ½"	
BBQ07889P	30" Warming Drawer	28 ¾"	20 ½"	10"	
BBQ07891P	Cutting Board and Drawer	13 ½"	19 ½"	3"	

Installation / Assembly

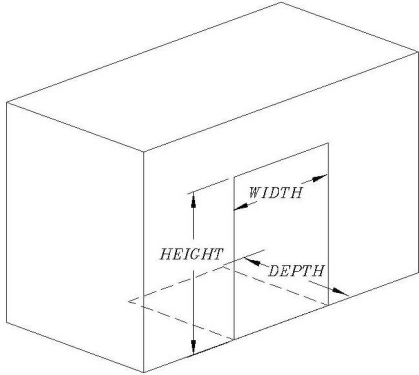
Model Number	Description	Width	Depth	Height	Cut-out for refrigerators, cocktail centers and access doors
BBQ07863P	3 Pull Out Drawer, SS Refr.	25"	22 7/8"	32 1/4"	
BBQ07857P	Propane Tank Compartment	14 3/4"	16 1/4"	20 1/2"	
BBQ07839P-18	Single Access Door	16 1/2"	2 3/4"	19"	
BBQ07839P-30	Double Access Door	28 3/4"	2 3/4"	19"	
BBQ07840P-18	18" Door and Drawer Combo	17"	20 1/4"	19 1/4"	
BBQ07840P-30	30" Door and Drawer Combo	28 3/4"	20 1/4"	19 1/2"	
BBQ07909	Complete Utility Storage Kit	51 1/2"	20 1/2"	19 1/2"	
BBQ07910	Paper Towel Storage	8 3/4"	6 1/2"	14 3/4"	
Cut-out dimensions for the following products are measured to include the frame.					
BBQ07843P	Beer Tap Refrigerator	21 1/4"	22"	34 1/4"	
BBQ07847P	Stainless Refrigerator	21 1/4"	22"	34 1/4"	
BBQ07848P	Deluxe Refrigerator, Glass door	25 1/4"	22"	34 1/4"	
BBQ07908	Ice Maker	15 1/4"	23 3/4"	34 1/4"	

Gas Requirements and Connection

IMPORTANT: Cal Flame™ grills are manufactured to operate on either liquid propane (LP) or natural gas (NG) and cannot be converted. To verify the grill's operating fuel, check the serial number label in the back of the chassis as you are looking at the grill from the front. Either LP or NG will be marked on the operating tab, indicating the proper operating fuel. Attempting to convert Cal Flame™ grills from one fuel to another may result in serious injury and will void the warranty coverage.

Always check the rating plate to make sure the gas supply you are hooking up to is the gas type the grill is manufactured for.

If you do not have an updated filler valve on your existing propane tank, you will need to purchase one at your local hardware store. Without it you will not be able to attach your tank to your Cal Flame™ grill or refill the tank at your local propane refill station.

Leak Testing Procedure

Perform a leak test at least once a year whether the gas supply cylinder has been disconnected or not. In addition, whenever the gas cylinder is connected to the regulator or whenever any part of the gas system is disconnected or replaced, perform a leak test.

As a safety precaution, remember to always leak test your grill outdoors in a well-ventilated area. Never smoke or permit sources of ignition in the area while doing a leak test. Do not use a flame, such as a lighted match to test for leaks. Use a solution of soapy water.

1. Prepare a leak testing solution of soapy water by mixing in a spray bottle one part liquid soap to one part water.
2. Make sure all the control knobs are in the OFF position.
3. Turn on the gas.
 - a. On natural gas systems, turn the main feed valve to the grill.
 - b. On LP systems, turn the cylinder valve knob counter clockwise one turn to open.

4. Apply the leak-testing solution by spraying it on joints of the gas delivery system. Blowing bubbles in the soap solution indicates that a leak is present.
5. Stop a leak by tightening the loose joint or by replacing the faulty part with a replacement part recommended by the manufacturer. Do not attempt to repair the cylinder valve if it is damaged. The cylinder must be replaced.
6. Turn all control knobs back to the full OFF position.

If you are unable to stop a leak:

1. Turn all control knobs back to the full OFF position.
2. Shut off the gas supply to the grill and release pressure in the hose and manifold by pushing in and turning any of the control valves one quarter turn counter-clockwise.
3. On LP systems, remove the cylinder from the grill.
4. Call an authorized gas appliance service technician or an LP gas dealer.

Do not use the appliance until the leak is corrected.

Installation / Assembly

LP Gas

Tank Requirements

For plumbed-in LP installation, use a convertible regulator and set it for LP gas.

Maximum line pressure for plumbed-in propane is 14" WC (3.5 kPa).
Minimum line pressure for propane is 11" WC.

The grill unit must be used with the gas pressure regulator. The regulator will control and maintain a uniform gas pressure in the manifold. The burner orifices have been sized for the gas pressure delivered by the regulator.

WARNING: Attempting to operate the grill unit without the gas regulator installed could cause an explosion and possible death.

Cylinder Specification

Any LP gas supply cylinder used with this grill must be:

- Constructed and marked in accordance with the *Specifications for LP-Gas Cylinders* of the U.S. Department of Transportation or the National Standard of Canada, *CAN/CSA-B339, Cylinders, Spheres and Tubes for Transportation of Dangerous Goods; and Commission*, as applicable.
- Approximately 12 inches in diameter and 18 inches high.

The maximum fuel capacity is 20 lbs. of propane, or 5 gallons. Full cylinder weight should be approximately 38 lbs. (43.7 lbs. nominal water capacity.) Never fill the cylinder beyond 80% full.

Place the dust cap on the cylinder valve outlet whenever the cylinder is not in use. Only install the type of dust cap on the cylinder valve outlet that is provided with the cylinder valve. Other types of caps or plugs may result in leakage of propane.

LP Gas Hook Up

An enclosure for an LP gas cylinder shall be vented by openings at the level of the cylinder valve and at floor level. The effectiveness of the openings for purposes of ventilation shall be determined with the LP-gas supply cylinder in place. This shall be accomplished in one of the following manners:

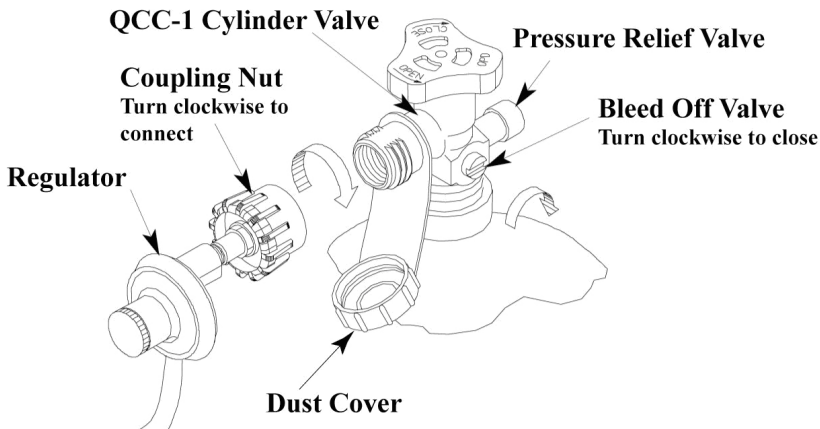

1. One side of the enclosure shall be completely open.
2. Enclosures that have four sides, complete with a top and bottom:
 - a. At least two ventilation openings at cylinder valve level shall be provided in the sidewall, equally sized, spaced at 180° (3.14 rad), and unobstructed. Each opening shall have a total free area of not less than one square inch per pound (7.1 cm²/kg) of stored fuel capacity, and not less than a total free area of 10 square inches (64.5 cm²).
 - b. Ventilation openings shall be provided at floor level and shall have a total free area of not less than one square inch per pound (7.1 cm²/kg) of stored fuel capacity and not less than a total free area of 10 square inches (64.5 cm²). If ventilation openings at floor level are in a sidewall, there shall be at least two openings. The bottom of the openings shall be at floor level and the upper edge no more than 5 inches (127 mm) above the floor. The openings shall be equally sized, spaced at 180° (3.14 rad) and unobstructed.
 - c. Every opening shall have minimum dimensions so as to permit the entrance of a 1/8 inch (3.2 mm) diameter rod.

Transporting and Storing LP Gas

Transport only one cylinder at a time. Ensure the cylinder is secured in an upright position with the control valve turned off and the dust cap in place. Store cylinders outdoors and out of reach of children. Do not store cylinders in a building, garage, or any other enclosed area.

Natural Gas

Requirements

Always check the rating plate to make sure the gas supply you are hooking up to is the gas type the grill is manufactured for.

IMPORTANT: Never connect the grill to an unregulated gas supply.

The installation of this appliance must conform with local codes or, in the absence of local codes, to the national fuel gas code, ANSI Z223.1a-1998. Installation in Canada must be in accordance with the standard CAN/CGA-B149.2, Propane Installation Code.

A licensed contractor or local gas company representative must perform all natural gas connections.

Ensure that the service supplying the grill is fitted with a shut off valve conveniently positioned near the grill and giving ease of access.

The grill must be isolated from the gas supply piping system by closing its individual manual shutoff valve during any pressure testing of the gas supply piping system at test pressures equal to or less than 0.5 psi (3.5 kPa).

The grill and its individual shutoff valve must be disconnected from the gas supply piping system during any pressure testing of that system at test pressure in excess of 0.5 psi (3.5 kPa).

Your Cal Flame™ grill for use with natural gas comes equipped with its own regulator that **MUST NOT** be removed. If, this regulator needs to be replaced use only the type specified by Cal Flame™ for this appliance.

Connection

1. Remove the rear panel from the barbecue to gain access to the regulator and gas connection point.
2. Connect a suitable flex connector to the grill regulator.
3. Check the grill controls to ensure all control valves are in the full OFF position.
4. Turn on the main gas supply and check all connections for leaks using soapy water as described in the leak testing procedure section.

Warning: If you see bubbles in the soapy solution at any of the connections, turn off the gas supply and tighten the connection. If tightening the connection does not seal the leak, it may be necessary to replace the flex hose.

Installation / Assembly

Installing and Replacing Infrared Burners

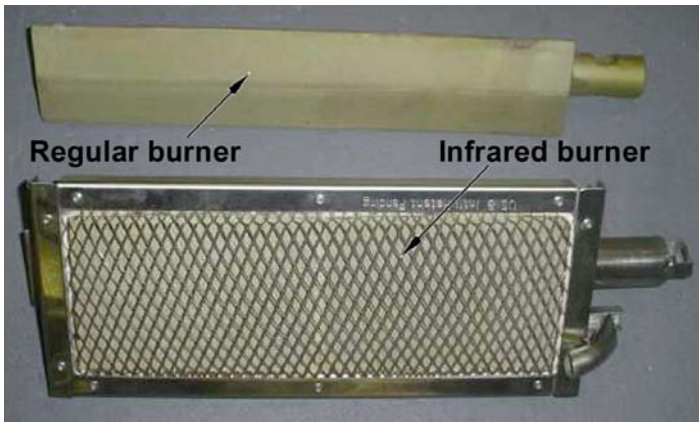

1. Disconnect or shut off the liquid propane or natural gas line connect to the grill. Wait until the burners cool down.
2. Open the hood and remove the grate and flame tamer on top of the burner you want to replace.

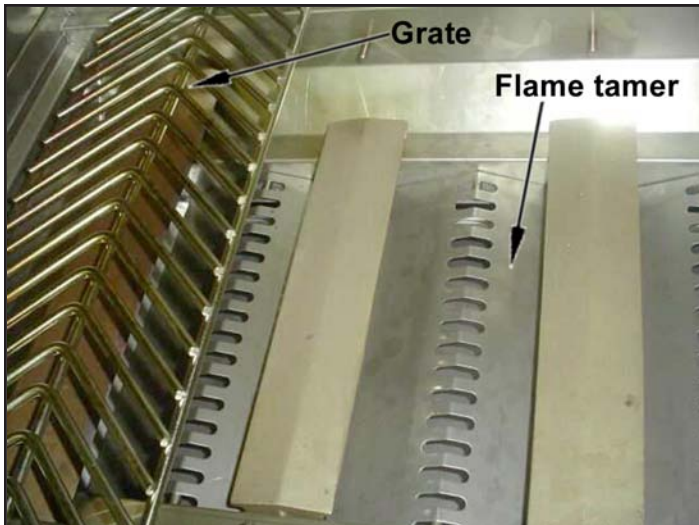

3. Through the access door underneath the grill, find the round stud and locking pin that locks the burner you want to replace.

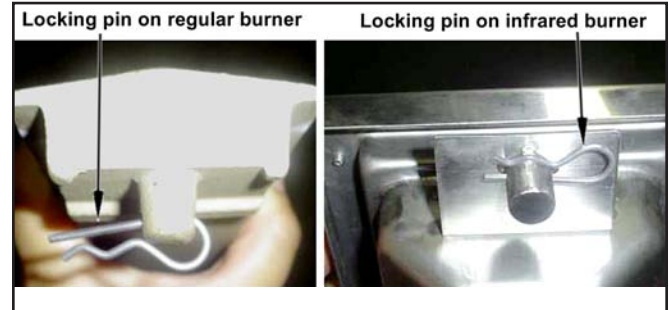

4. Carefully remove the locking pin with your fingers.
5. Raise the stud from the locking hole and move the burner forward carefully to release it from the ignition and gas supply valve.
6. Take the burner out of the grill and store it in a safe and dry place.
7. Install the infrared burner. Align the gas inlet on the burner with the gas supply valve on the grill and torch tube with ignition. Make sure they align perfectly. Slide the stud at the other end into the locking hole.
8. Adjust the infrared burner. Make sure the burner is aligned and in position.
9. Install the locking pin. Through the access door underneath the grill, find the stud to lock the burner in place. Install the locking pin. Make sure the locking pin is secured correctly.
10. Repeat steps 2 through 9 if you want to replace other burners.
11. Put back the grate you just removed. (You don't need the flame tamer for infrared burners.)
12. Reconnect or turn on the gas line.

If you want to change back to regular burners, just follow the procedure above in reverse order.

Installing the Transformer

All grills with electrical components such as lights or a convection fan will require the transformer to be installed and plugged in before you can use it. This needs to be done **before** the grill is inserted in the island or modular cart. When the transformer is attached to the grill chassis, use care in placing the grill in the island cutout to avoid hitting the transformer.

1. Remove the transformer and the metal screws from the plastic bag.
2. Place the grill on a sturdy surface and tilt it back to show the underside of the grill.
3. Using the metal screws, attach the transformer to the left side of the grill near the internal electrical connection. Attach the metal plate to the outside surface of the grill as shown in the figure below.
4. When you have firmly tightened the screws and nuts, connect the plug from the transformer to the grill. Screw on the stainless steel retainer.



Installation / Assembly

Installing Grills in Modular Carts

You will need a second person to help you to avoid damaging the grill, the transformer, or your barbecue island.

Keep fingers away from where the grill will be supported on the cart. Your fingers could become trapped and serious injury could occur.

1. Slowly lower grill unit onto the cart, making sure that screws line up with slots on top of the cart. Ensure that no electrical cords or gas lines become trapped between any part of the cart and any part of the grill.
2. The grill should sit flat on the cart all the way around. Gently realign cart sides to allow them to sit under outside lip of grill.
3. Check that all burner control knobs are in the OFF position.
4. Attach the gas connector to the LP tank.

When handling the LP gas line and connectors, do not allow them to come in contact with any metal surfaces of the cart or cabinet. Do not drop LP connectors.

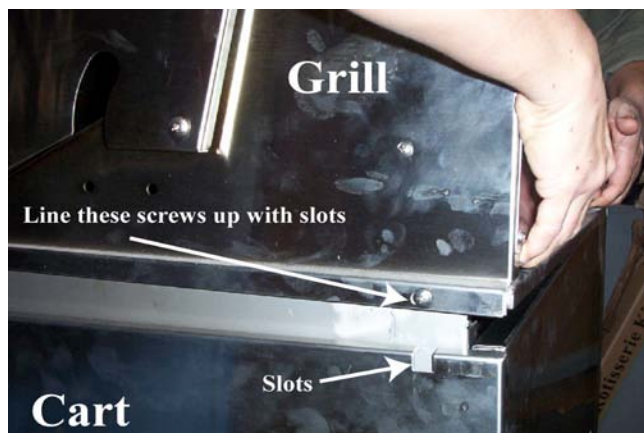

Installing Grills in Barbecue Islands

You will need a second person to help you to avoid damaging the grill, the transformer, or your barbecue island.

Before installing a grill or side burner in any island or cut out, make sure that the opening is not bigger than the outside frame of the grill unit. The grill should rest on the lip of the frame. For drop-in accessories, adequate cross ventilation must be designed into enclosure to ensure the drop-in grill or side burner does not become overheated.

Pay careful attention to the location of gas lines. Gas lines should be routed away from sources of heat and should make as few bends as possible.

Check to see if gas line connections will be accessible when grill is installed.

- If gas line connections are not easily accessible when the grill is installed, support the grill above counter level and attach the gas lines to the grill. When the gas connections are made, slide the grill into the cut out.
- If gas line connections are accessible when the grill is installed, slide the grill into the cut out and then attach the gas lines.

Be very careful not to kink gas lines when lowering the grill or side burner into the cut out.

Keep your fingers away from where the grill will be supported on counter. Your fingers could become trapped and serious injury could occur.

Check to make sure the grill is level and is supported around the entire outside edge. If the grill is not level or is unstable, use non-combustible shims under the outside lip to stabilize it.

Perform the leak test procedure as described earlier in this manual.

Installing Barbecue Cart End Shelves

1. Prepare the installation of handle: 2 hex screws, 2 washers
2. Use finger to thread the hex screws and washers into the threads on both ends of the handle.
3. Use ratchet to tighten the hex screws on both ends. The handle has been installed onto the shelf.
4. Take the three screws off on both sides of the cart to install the mounting bracket.
5. Install the mounting brackets on both sides. Make sure the mounting brackets are in the correct orientation. Two mounting brackets have been installed onto the cart.
6. Slides the shelf into the brackets from bottom.
7. Make sure to slide into the brackets on both side evenly.
8. Slide the shelf fully onto the mounting brackets.
9. Lift and rotate the shelf so it slide back into the brackets.
10. Keep the shelf in the normal open position.
11. Prepare to install stop brackets under the mounting brackets on both sides.
12. Remove one screw and loose the other screw so the stop bracket can be placed as shown. Tighten both screw to hold the stop bracket.

Installing the Rotisserie

Attach the two brackets to the sides of the grill, one on each side, using two screws as shown below.

Slide the rotis motor on one of the brackets as shown below. The rotis motor will work on either side of the grill.

Remove the metal cap protecting the outlet that provides power for the rotis motor. Plug in the motor cord and screw on the retainer nut to keep the plug in place.

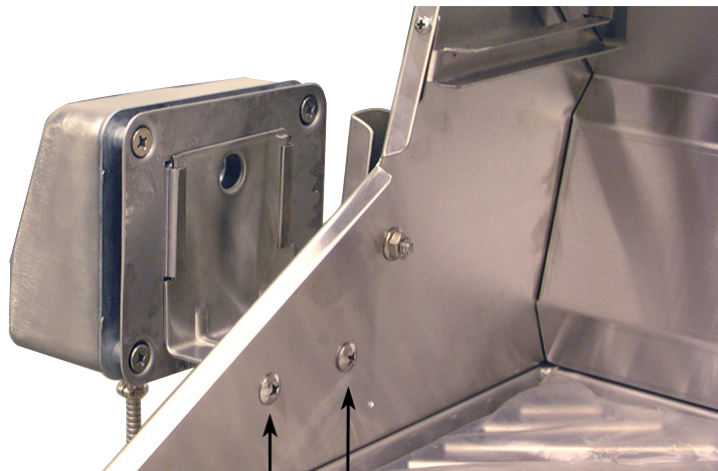

Attachment screws
for rotis motor



Installation / Assembly

Installing Side Burners

1. Assemble a 3/8" pipe nipple to the 3/8" pipe tee using Teflon tape or pipe sealant. Use only sealant that is approved for use on LP gas.
2. Install the pipe tee assembly to the grill intake pipe. Tighten assembly and align the branch opening of the tee with the hole of the cabinet.

Items Included with Barbecue

- 1) "T" adapter (3/8")
- 2) 2 each Hose 3/8" Fittings
- 3) Regulator/ Hose

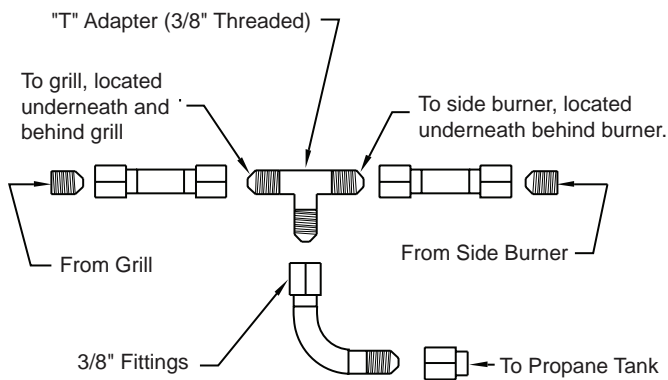

NOTE: You will need to use a gas rated sealer on gas connectors that are not flared.

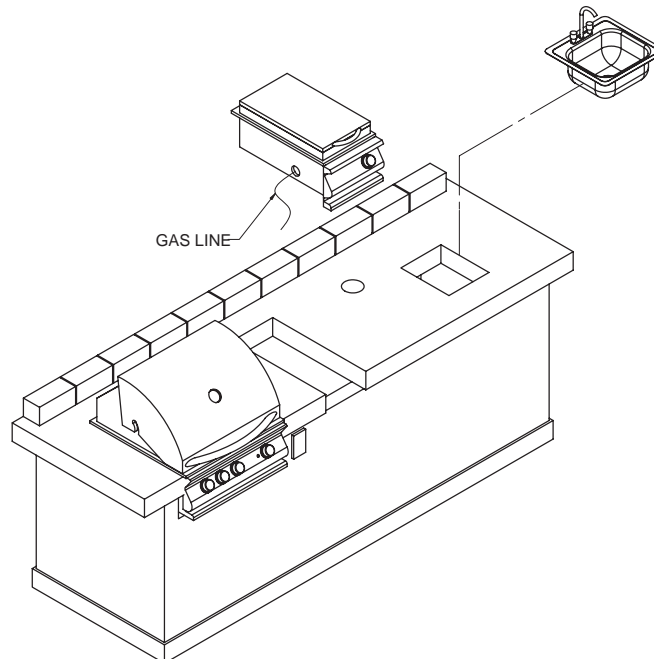

3. Connect the flexible hose (male end) to the pipe tee.
4. Install and secure the side burner into the island by simply setting it in place.
5. Connect the female end of the flexible hose to the side burner intake pipe.
6. Connect gas supply to the grill.
7. Check for gas leaks using soap water solution.

- (A) Open barbecue door. Install hose with regulator on propane tank. Then connect other end to "T" adapter. Make sure to use gas rated tape seal when installing adapter to insure proper seal.

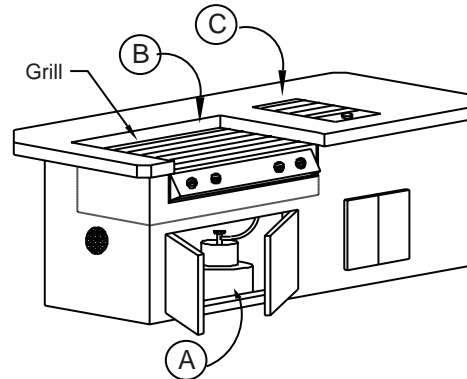

- (B) Then take other end of "T" adapter with hose attached and connect to end of male located underneath and at the back of the grill. (Use gas rated tape seal on all connections).

- (C) Connect the last open line to the side burner (Use gas rated tape seal on all connections)

Operating Your Barbecue

Read all instructions before you operate your grill.

We recommend you wash your entire grill with soap and water prior to lighting it for the first time. Oils are used during the manufacturing process and some residual oil may still be on the stainless steel parts of your grill. Washing will reduce the possibility of discoloration. We also recommend you keep your grill covered when not in use. This will minimize the amount of dust and dirt that accumulates on your grill and extend the life of your grill.

Remember to use your Cal Flame grill safely by following these reminders:

- It is dangerous to use barbecue grills and side burners in any manner other than for what it is designed for.
- Do not use charcoal in a gas grill or side burner or electric grill.
- Do not heat sealed containers such as cans or jars on grills or side burners. Explosion may result resulting in injury or death. Any sealed container, such as a pressure cooker, must have a properly operating pressure relieve valve to minimize explosion hazard.
- Never put combustible material such as paper, cloth, or flammable liquids on your grill at any time. Do not use grill, side shelves, cabinets, or any area around grill to store flammable materials.
- Never operate main burners and rear infrared convection burners at the same time. Excessive grill temperatures will result. Never allow your grill temperatures to exceed 500° F.

Grill Controls

The controls shown at right are for the Cal Flame™ drop-in grills and stainless steel carts. Familiarize yourself with these controls before using your Cal Flame™ barbecue.

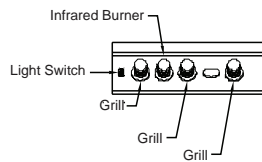
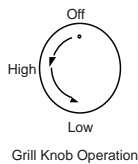

BBQ07873 - 3 Burner Grill
CR3000 - 3 Burner Cart

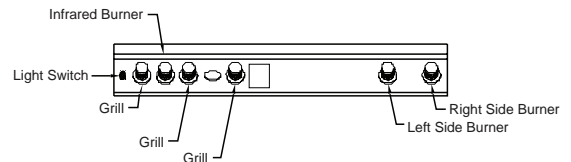

CR3000S - 3 Burner Cart with Sideburner

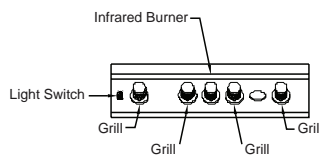

BBQ07874 - 4 Burner Grill
CR4000 - 4 Burner Cart
CR4000C - 4 Burner Cart with Convection

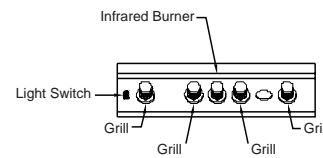

BBQ07874F - 4 Burner Flat Drop-in Grill

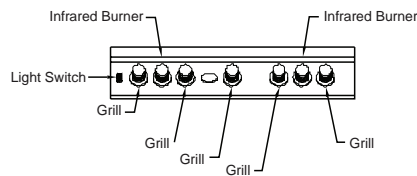

BBQ07875 - 5 Burner Grill

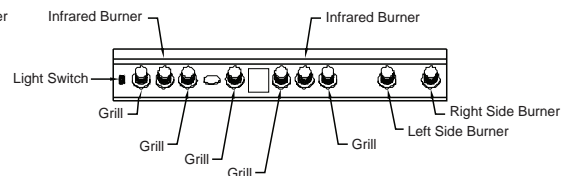

CR5000DS - 5 Burner Cart with Double Side Burners

Warning

NEVER cover the entire cooking or grill surface with griddles or pans. Overheating will occur and burners will not perform properly when combustion heat is trapped below the cooking surface.

CAUTION: NEVER spray water on a hot gas unit. This may damage porcelain or cast iron components.

Operating Your Barbecue

Lighting the Grill

Each time you light the grill, check the following:

- Inspect the hose before using the grill. If there is excessive abrasion or wear, or if the hose is cut, it must be replaced prior to using the grill. If you need a replacement hose, contact your Cal Flame dealer.
- Ensure the area around the barbecue is clear of flammable substances such as gasoline, yard debris, wood, etc.
- Ensure there is no blockage of the airflow through the vent space located below the face of the unit.
- When using propane gas:
 - **Keep the special ventilation openings in the enclosure free and clear of debris.**
- **If connected to a propane cylinder, carefully inspect the rubber hose attached to the regulator before each use.**
- **Ensure the propane cylinder, regulator, and rubber hose are installed in a location not subject to heating above 125° F (51° C).**
- Ensure the burner flames burn evenly along both sides of each burner with a steady flame (mostly blue with yellow tipping). If burner flames are not normal, check the orifice and burner for insects or insect nests.
- Ensure the in-line gas valve or gas cylinder valve is always shut OFF when the barbecue is not in use.
- Do not operate the side burner with its cover closed or the back burner with its cover installed.

Electronically Lighting the Grill and Infrared Burners

1. Open the hood.
2. Keep your face as far away from the burners as possible.
3. Rapidly rotate the burner knob counter clockwise past the light position to HIGH. You will hear a loud click as the electronic lighter produces a spark.
4. Listen for the sound of the gas igniting. If the burner does not light on the first try, repeat immediately.
5. If the burner does not light after three attempts, turn the control knobs to the OFF position. Wait five minutes until the gas clears before attempting to light it again.
6. Repeat the procedure or try the manual lighting procedure below.
7. Upon successful lighting, repeat the process on the other burners you wish to light.
8. To shut off the burners, rotate the knob and turn to OFF. It is normal to hear a popping sound when the burners are turned off.

Manually Lighting the Grill and Infrared Burners

WARNING: Do not use standard matches or cigarette lighters to perform match lighting procedures. Serious burns can occur and lighters can explode.

1. Open the hood.
2. If you have just attempted to light the burner, allow five minutes for any accumulated gas to dissipate.
3. Slide out the drip tray from the grill.
4. Keep your face as far away from the burners as possible.
5. Light and insert a long stem match, holding it near the burner ports.
6. Push in and turn the control knob just past the LIGHT position to HIGH.
7. Listen for the sound of the gas igniting. If the burner does not light after five seconds, turn the control knobs to the OFF position. Wait five minutes until the gas clears before attempting to light it again.
8. If the burner does not light after several attempts see Troubleshooting Guide in the back of this manual.

Basic Grill Operation

Before lighting, make sure all burner controls are off. Do not attempt to light the burners if the smell of gas is present. Check the connection with a soap and water solution after attaching the hose. For LP units, make sure there is gas in the tank and it is sitting upright. For natural gas units, make sure the shut off valve is on.

1. Make sure the drip tray is in place.
2. Light the grill burners using the instructions on the previous page.

3. Turn the control knob to HIGH and preheat the grill for 15 minutes. Close the top cover during the appliance preheat period.
4. Place the food on the grill and cook to desired completion. Adjust heat setting if necessary. You may set the control knob to any position between HIGH and LOW.
5. Allow the grill to cool and clean the drip tray after each use.

Do not leave the grill unattended while cooking.

Cooking with the Rotisserie

The rotisserie burner is an infrared type, which provides intense searing radiant heat. It is designed to cook items from the back using infrared heat. The location of the burner allows the placement of a rotisserie-basting pan (NOT included) beneath the food to collect juices and drippings for basting and gravy.

The rotisserie does not require an additional outlet as it is powered by a 12-volt input located on the side of the grill connected with a stainless steel sheathed power cable.

1. To load the rotisserie rod, hold the handle firmly while sliding one of the fork assemblies (prongs facing away from the handle) onto the rod. Push the rod through the center of the food, then slide the other holder (prongs toward the food) onto the rod. Center the meat on the rod and push the fork assemblies firmly together. Tighten the thumbscrews. To secure any loose portions of your meat, use butcher string (never use nylon or plastic string). Place a basting pan under the food to collect the drippings.

2. To use the rotisserie, first mount the motor on the left side of the grill. Place securely onto support bracket.
3. The rod of the rotisserie system is assembled into the motor by placing the pointed end into the motor and resting the threaded end on the support at the side of the grill. Once the rod is pushed as far as possible into the motor, the grooved end of the rod should rest on the right side bracket.
4. If necessary, to offset unbalanced loads, slide the counter weight on to the rod. With the counter weight loose, allow the loaded rod to rotate and come to a stop. Now rotate the counter weight above the rod in a vertical position and tighten the thumbscrew. You can slide the counter weight away from or closer to the rotisserie rod as needed for balanced operation. Once lit, the rotisserie burner will reach cooking temperature in about one minute. The orange/red glow will even out in about five minutes.

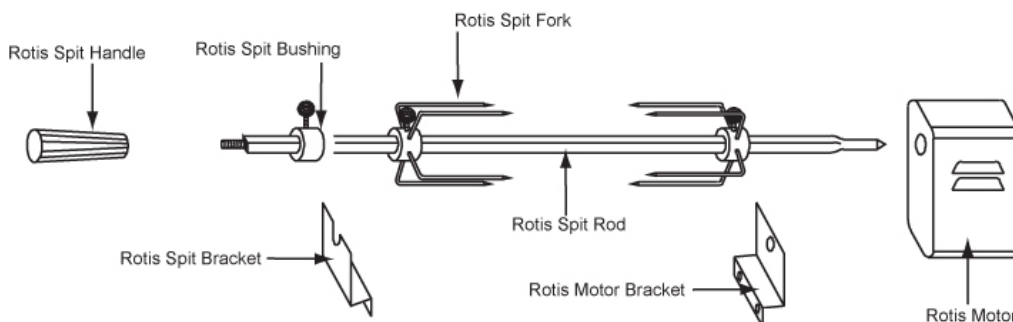

Operating Your Barbecue

Cooking with a Convection Grill

A convection grill has an internal fan that circulates heated air evenly throughout the grilling area when the hood is closed. Cooking in this way distributes heat more efficiently so you no longer have to be concerned with “hot spots” on the grill where food tends to burn. The fan switch is located at the far left of the front panel of the grill.

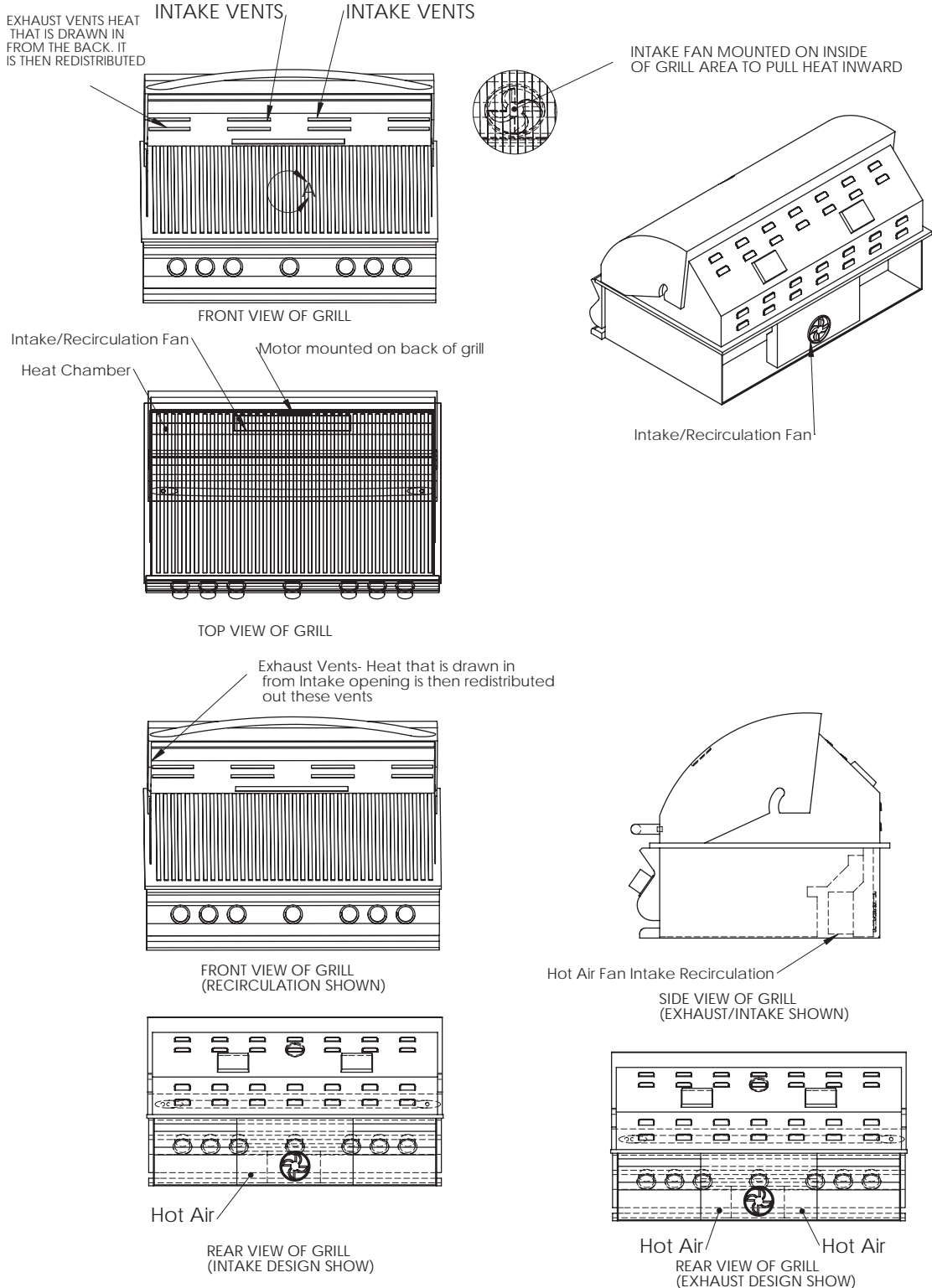

Charcoal Grill

Lighting Instructions

NEVER use flammable materials and fluids such as gasoline, kerosene, butane or propane, diesel fuel, or alcohol to light or re-light fires. Keep the grill away from such substances when lit.

Use high quality hardwood charcoal to ensure a good flame. Charcoal briquettes made from maple, oak, birch, or elm woods will burn cleanly, minimizing smoke and unpleasant odors.

1. Open the hood and remove cooking grates.
2. Place charcoal on the ashtray at the bottom of grill and arrange charcoal in a pyramid shaped stack.
3. Add charcoal lighting fluid according to manufacturer's instructions. Let it stand for about a minute to let fluid penetrate charcoal.
4. Carefully light charcoal, allowing it to burn approximately 15 to 20 minutes or until a light gray ash develops.

Leave about a one-half inch space between each piece of charcoal. This helps to avoid flare-ups from the meat juices and provides the even heat best suited for grilling.

Grilling

NEVER allow children or pets unattended in an area where a grill is being used. Never allow children to sit, stand or play on or around the grill at any time. When in use, certain areas of the grill get hot enough to cause severe burns.

Leave the hood open for "Texas Style" open air grilling. Close the hood for "Smoker" cooking.

For the greatest concentration of heat, leave the hood open. Adjust the crank handle to lift the charcoal tray up so the burning charcoal will be close to the grilling meat. Lower the charcoal tray to slow the grilling temperature.

Storage

Never store the grill with ashes or combustible materials inside. Do not store the grill until the fire is completely extinguished and the grill body has cooled.

Turning on and off the Lights and Fan

The ON / OFF switch controlling your halogen light is located at the control panel on the front lower left side.

Certain models of the Cal Flame grill are equipped with either one or two halogen light.

Your grill is equipped with a grounded (3 prong) 120 VAC plug located in the lower left rear corner of your cart and must be plugged into a permanent grounded 120 VAC outlet with a dedicated 15amp GFI breaker. DO NOT cut or remove the ground prong as this may result in fire, electrical shock or other personal injury. This electrical source provides power to the lights.



Operating Your Barbecue

Griddle

When sliding the griddle out of the enclosure, always do it slowly as the heavy weight may cause you to suddenly drop the griddle. Lift the griddle out of the enclosure instead of sliding it all the way out.

Remove two cooking grates for the griddle space. Leave grease in the front drain when cooking. Wait until the griddle cools down when done cooking. Use both hands when removing the griddle and draining the grease.

Before storing the griddle, make sure it is clean and dry. Slide the griddle into the enclosure for safe and easy storage.

Drop-In Food Warmer

Attach this three-pan food warmer to your favorite bartending center or grill and serve a variety of hot, fresh hors d'oeuvres and side dishes. The food warmer has three steamer pans and a built-in fuel drawer.

1. Remove one steamer pan and fill the container pan with approximately 2"-3" warm water. Gently place the steamer pan back on to the container pan.
2. Open the sterno fuel drawer. Remove the sterno fuel can holder covers. Place two sterno fuel cans into the can holder.
3. Using a butane lighter or long stem match, light the sterno fuel. For safety, the rear one first.
4. Close the drawer.
5. Place food to be warmed into the steamer pans and cover with pan lids.
6. To extinguish the sterno fuel flame, open the drawer and carefully replace the fuel holder covers. Flames will go out.

IMPORTANT

- The water in the container pan is a scald and burn hazard as it gets hot. Do not attempt to empty it until it is cooled.
- Do not burn sterno fuel with the drawer open.
- Do not leave sterno fuel burning unattended. Do not leave children unattended around food warmer during and immediately after use.

30" Warming Drawer

Preheating Instructions

The warming drawer is designed to keep foods at a safe temperature (above 140°F) when used according to the operating instructions. The drawer must be pre-heated for at least 1 hour on the highest setting. If the warming drawer isn't pre-heated, the internal temperature of the food being warmed could fall below the minimum safe level and bacteria could develop. Always pre-heat the drawer according to instructions described in this manual.

Be certain to use only dry potholders. Moist or damp potholders on a hot surface may cause burns from steam. Do not use a towel or other bulky cloth in place of potholders.

1. Never store anything in the warming drawer. Flammable materials can catch fire, plastic items may melt or ignite and other types of items could be ruined.
2. Do not hang articles from any part of the appliance or place anything against the drawer. Some fabrics are quite flammable and could catch on fire.
3. For safety reasons and to avoid damage to the appliance, never sit, stand, or lean on the warming drawer door.
4. For personal safety reasons, wear proper apparel. Loose fitting garments or hanging sleeves should never be worn while using this appliance. Some synthetic fabrics are highly flammable and should not be worn while using this appliance.
5. Do not use aluminum foil to line any part of the warming drawer. Using a foil liner can be a fire hazard and can obstruct the flow of heat and ventilation air. Foil is an excellent heat insulator and heat will be trapped underneath it. This trapped heat can upset the performance of the warming drawer parts.

Temperature Settings

The dial on the right of the unit is the on/off and temperature control adjustment. When the dial is turned clockwise from the off position to the low position, the unit will maintain a temperature approximately 175°F. By rotating the dial clockwise to the high position, the drawer will reach a temperature of approximately 230°F.

To use, turn the thermostat dial to a temperature setting:

Operating Your Barbecue

High	210°F – 230°F
Medium	190°F – 210°F
Low	175°F – 190°F

- If you use the tray, preheat it while preheating the warming drawer.
- Preheat any empty serving dishes to be used while preheating the drawer.
- Add cooked, hot food in its cooking container or heat a safe container.
- You may use aluminum foil to cover food containers.

Safety Practice & Precautions

- As with any cooking or heating appliance, never leave the warming drawer unattended when warming food.
- Only certain types of glass, heat proof glass-ceramic, ceramic, earthenware or glazes are suitable for temperature changes.
- Never heat unopened containers, as a build up of pressure may cause the container to burst.
- 120V 5 amp minimum circuit required.
- Grease is flammable. Avoid letting grease deposits collect in the warming drawer. Clean up any spillage.
- DO NOT use water on grease fires. Turn OFF the warming drawer, then smother the fire with baking soda or use a dry chemical or foam-type fire extinguisher.
- When opening a drawer while warming liquids, the drawer must be opened slowly to avoid spillage.

- Use care when opening a hot warming drawer. To avoid severe burns, open slowly, allowing the hot air or steam to escape before reaching in to remove or replace any foods.
- Do not repair or replace any part of this appliance unless it is specifically recommended in this manual. All other servicing should be referred to a qualified service technician. Service technicians must disconnect the power supply before servicing this appliance.
- When using the warming drawer: DO NOT TOUCH THE INTERIOR SURFACES or the exterior area immediately surrounding the door until it has had sufficient time to cool to avoid burn injuries.
- Clean the warming drawer with caution. Avoid steam burns. Do not use a wet sponge or cloth to clean the appliance while it is hot. Some cleaners produce noxious fumes if applied to a hot surface. Follow directions provided by the cleaner manufacturer.
- Be sure all the controls are turned off and the appliance is cool before using any type of aerosol cleaner on or around the appliance. The chemical that produces the spraying action could, in the presence of heat, ignite or cause metal parts to corrode.
- Do not touch the heating element or interior surfaces of the warming drawer. Even if they appear dark in color. They may still be hot enough to cause burn injury. Allow sufficient time to cool.
- Do not allow flammable materials which may ignite to come in contact with the hot heating element or the interior surface of the warming drawer until the unit has a sufficient time to cool.

Cleaning and Maintenance

Cleaning and Maintenance

To ensure safe and proper maintenance, we recommend you follow these directions carefully.

Clean internal parts of the grill regularly as determined by the amount of use and foods cooked. The entire grill should be cleaned at least once a year.

In addition, keep the area around your grill or cart clear and free from combustible materials, gasoline,

and other flammable vapors and liquids. Do not obstruct the flow of combustion and ventilation air.

If your LP-gas grill is placed in a stationary barbecue island, keep the access door for the propane cylinder clear of any obstruction. Ensure the ventilation opening for cylinder enclosure is kept clear.

DISCONNECT ELECTRICAL SUPPLY BEFORE CLEANING ANY PART OF THE GRILL.

Burners

Spiders and small insects occasionally inhabit or make nests in the burner tubes, obstructing the gas flow. Sometimes this results in a type of fire in and around the gas tubes called “flashback”. To reduce the risk of flashback, this procedure should be followed at least once a month or when your grill has not been used for an extended period of time.

IMPORTANT: Prior to starting this procedure, turn OFF all of the gas control knobs, shut off the fuel supply, and disconnect the fuel line.

1. Remove burners from the grill by carefully lifting each burner up and away from the gas valve orifice.
2. Use a wire brush to clean the outer surface of each burner to remove food residue and dirt. Clean any clogged ports with a stiff wire such as an opened paper clip.
3. Inspect each burner for damage (cracks and holes). If any damage is found, replace the burner and discontinue grill usage.
4. Upon reinstallation, inspect the gas valve orifices for cleanliness and condition and the location of the igniters.

Drip Pan

The full width drip pan will collect grease from the main grill area. The pan should be cleaned after every use to avoid the possibility of a grease fire. Be sure to allow the drip pan to cool prior to cleaning. You may clean the drip pan with a solution of warm soapy water. Make sure to rinse thoroughly to avoid staining.

Care of Stainless Steel

Do NOT use wire wool pads, scrappers, harsh abrasive, scoring materials, bleaches, or harsh cleaners on your cart or grill, or allow salt and vinegar mixtures to remain in contact for a long period of time. This will cause scratching, scoring, rusting and pitting.

We recommend that you clean stainless steel components with a cleaner that is approved for stainless steel and only clean when the grill is cool and in indirect light. Never use steel wool.

Covering Your Cart or Grill

When not in use and after cooling, cover your cart or grill with our full length, zippered side canvas cover. (See your local Cal Flame dealer for details.) The cover will help protect your cart or grill from detrimental effects of weather and environmental pollutants. Never put a cover on a hot grill. Allow the grill to cool before covering.

After Use Care

The easiest way to clean the grill is immediately after cooking is completed and after turning off the flame.

- Scrub the grill rack with a brass bristle barbecue brush and hot soapy water.
- Wipe the grill with a damp soapy cloth and rinse with warm/hot, clean water. For more tenacious deposits, including oil, grease and water-borne deposits, use a multipurpose cream cleanser and apply with a soft, damp cloth.
- Dry with a soft, dry, clean towel if preferred.

Island Cabinets

Be sure to unplug the electrical supply before cleaning any part of your Cal Flame barbecue. Spray cabinet area with a soap and water solution. Rinse with a gentle stream of fresh water.

Griddle

To prevent burns or injury, make sure the griddle is completely cool before cleaning.

The griddle is made from non-magnetic, 304 grade stainless steel. There are various stainless steel cleaners available. Always use the mildest cleaning procedure first, and always scrub in the direction of the grain. Soapy water should be sufficient for most cleaning. A sniff brush may also be helpful in removing grime and food deposits. Wipe all area dry before storing.

Charcoal Grill

To prevent burns or injury, make sure the grill is completely cool before cleaning. After initial usage, areas of the grill may discolor from the grill's heat.

There are various stainless steel cleaners available. Always use the mildest cleaning procedure first, and always scrub in the direction of the grain. Soapy water should be sufficient for most cleaning.

DO NOT use oven cleaners or abrasive cleaners on enameled surfaces. They may damage the finish, causing accelerated wear.

Ash Removal

Remove the ashes as soon as possible after each use. Wait until the charcoal has cooled, slide out the drip pan and pour out the ashes. You can save the larger pieces of charcoal for the next time you cook. Use a garden hose to wash out accumulated grease and ashes. Allow the drip pan to dry before reinserting into the grill.

Cooking Grates

Use a solution equal parts detergent and hot water just as you would for any cooking equipment. A stiff brush may also be helpful in removing grime and food deposits.

Hood and Body

Wipe the inside hood and body with detergent and hot water. The external surfaces may be cleaned in the same fashion. Wipe all area dry before storing.

Storage

For your safety, make sure unit is cool and wood and charcoal embers completely extinguished before storing.

Drop-in Food Warmer

To prevent burns or injury, make sure the food warmer is completely cool before cleaning. The drop in food warmer is made from non-magnetic, 304 grade stainless steel. There are various stainless steel cleaners available. Always use the mildest cleaning procedure first, and always scrub in the direction of the grain. Soapy water should be sufficient for most cleaning. All parts of the food warmer can be cleaned with hot soapy water, rinsed, dried and buffed with a heavy pile cloth.. Be sure to rinse thoroughly and to wipe dry to avoid watermarks.

Note: DO NOT use oven cleaners or abrasive cleaners on enameled surfaces. They may damage the finish, causing accelerated wear.

30" Food Warmer

- Be careful cleaning any part of this appliance, particularly the drawer box and back of the drawer face. All parts of the drawer can be cleaned with hot soapy water, rinsed, dried and buffed with a heavy pile cloth. Always try this first, as it is the mildest cleaning procedure.
- Be sure the warming drawer is turned off and the appliance is cooled before using any type of aerosol cleaner on or around the appliance. The chemical that produces the spraying action could, in the presence of heat, ignite or cause metal parts to corrode.
- Use the mildest cleaning procedure first. Some brands of cleaners are harsher than others, read their directions. Try in a small area first.
- To avoid marring the surface always rub the metal finishes in the direction of the polish grain lines. The cleaner will be more effective when used in the direction of the polished lines.

Cleaning and Maintenance

- Use only clean sponges, soft cloths, paper towels, plastic or non-metal soap pads for cleaning or scouring, as recommended in this section.
- Be sure to rinse thoroughly and to wipe dry to avoid watermarks.

Drawer	Clean the drawer with warm soapy water.
Drawer Front	Clean same as drawer.
Gasket	Clean with warm soapy water.
Knobs	The ON/OFF temperature knob may be removed for cleaning.
Drawer Cavity	Same as drawer above.
Heating Element	Care should be taken when cleaning the heating element. Only clean the element when the unit is cool. Use warm soapy water on damp cloth.

Light Bulb Replacement

WARNING: Never attempt to replace a light bulb when the grill is in use. Serious burns will result.

WARNING: Never touch halogen bulbs with your bare fingers. Use a tissue or a small piece of paper to handle bulbs. Oils from your hands will damage halogen bulbs.

Light Removal

1. Open the grill hood and locate the glass light covers at the back of the grill.
2. Using a small screwdriver, gently pry the light cover away from the housing. *Be extremely careful prying off the light cover.* You may damage the light cover as a result.
3. Unscrew the two screws located at the side of the white ceramic light fixture.
4. Pull the burnt bulb out of the socket.

Light Replacement

1. Using a tissue or small piece of paper, carefully push a new bulb into the socket, making sure both wires on the bulb go into the light socket evenly.
2. Tighten the two screws on the side white ceramic light fixture.
3. Carefully replace the light cover by snapping it in place.

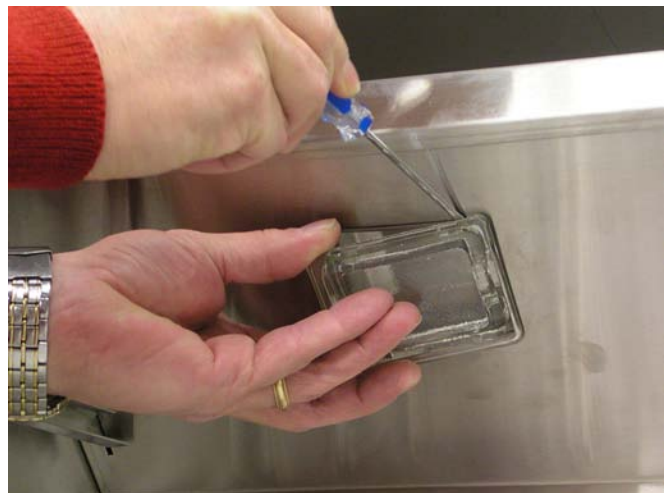

Troubleshooting

Problem: Smell of gas is present

Solution: Check for loose connections in the gas line. Perform a leak test following the procedure described in this manual.

Problem: Burner does not ignite

Solution: Use the following procedure with the figure below.

Check the position of the sparker tip. It should be pointing forward towards the front of the burner.

- Make sure there is a blue spark at the electrode tip to the burner.
- Make sure the igniter wire is connected firmly to the valve ignition device and the electrode.
- Make sure the valve orifice is free of any debris, dust or grease.
- Make sure the valve orifice is aligned inside the front hole of the burner.
- If there is no spark at all, replace the electrode or igniter wire.

Note: Turn off the gas at the source while troubleshooting.

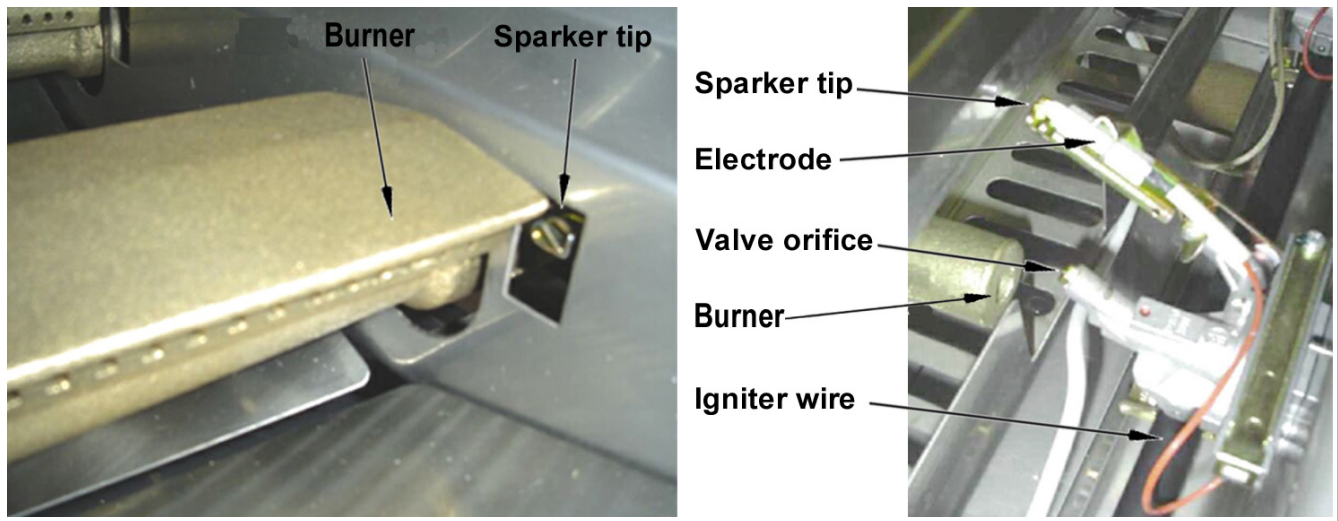

Problem: Burner tube is misaligned over the orifice

Solution: Reposition the burner tube so that it is properly seated over the orifice.

Problem: Obstruction in the gas line

Solution: Remove the fuel line from grill. (Do not smoke or perform any maintenance in the vicinity of an open flame.) Open the gas valve for one second to blow out any debris. Close off the gas valve and reconnect the fuel line securely.

Problem: Yellow Flame

Solution: Once the entire burner is operating, check the flame color to be sure that it is mostly blue. Some yellow at the tips may be present due to impurities in the fuel. If the flame is golden or yellow in color, the reason could be seasoning salts, oil film, or other foreign matter on the burner.

Appendix

Problem: Plugged orifice

Solution: Unplug the orifice as follows:

- Remove cooking grills, flame tamer and grease tray.
- Remove burners from the bottom of the firebox by pulling the cotter pin from beneath the burner peg using a standard screwdriver or needle nose pliers.
- Carefully lift each burner up and away from the gas orifice.
- Remove the orifice from the control valve.
- Gently clear any obstruction with a fine wire.
- Reinstall the orifice, reinstall the burners over the orifices, and seat each burner peg into position hole at the bottom ledge of the firebox.
- Replace all cotter pins.
- Replace cooking components and grease collectors.

If an obstruction is suspected in the control valve, contact your local Cal Flame dealer for assistance.

Problem: Misalignment of Igniter on Burner

- Solution:**
- Check for proper position of the electrode tip, which should be pointing forward towards the front of the burner and free of grease to allow proper sparking.
 - The ignition wire should be connected firmly to the valve ignition device and electrode. Replace the ignition wire if it is frayed or cracked.
 - With the gas supply closed and all control knobs set to the off position, check each position igniter individually for the presence of a spark at the electrode. Push each knob in fully and rotate it about 1/4 turn to the left (counter-clockwise) until you hear a loud click. The trigger hitting the strike block should produce a blue spark at the electrode tip. Return control knob to the off position before checking the next igniter.
 - While the grill is still hot, wait for a minimum of five minutes before commencing re-ignition. (This allows accumulated gas fumes to clear.) If all checks / corrections have been made and the gas grill still fails to operate properly, contact your local Cal Flame dealer.

Problem: Flashback

Solution: When fire occurs in and around the burner tubes, immediately turn off gas at its source and turn the control knob(s) clockwise to the 'OFF' position. Wait until the grill has cooled off and then clean the burner tubes and burners as described on page of this manual.

Replacement Covers

Cal Flame Drop-Ins

BBQ010	COVER, GRILL, SMALL, 3 BURNER
BBQ011	COVER, GRILL, MEDIUM, 4 BURNER
BBQ012	COVER, GRILL, LARGE, 5 BURNER
BBQ013	COVER, SIDE BURNER, SINGLE & DOUBLE

Cal Flame Carts

BBQ835CR4	BARBECUE CART COVER, 4 BURNER, BLACK
BBQ835CR5	BARBECUE CART COVER, 3 & 5 BURNER, BLACK

Location of Serial Number Plate

The serial number of your Cal Flame grill is located on the back and is visible when the hood is down as shown below.

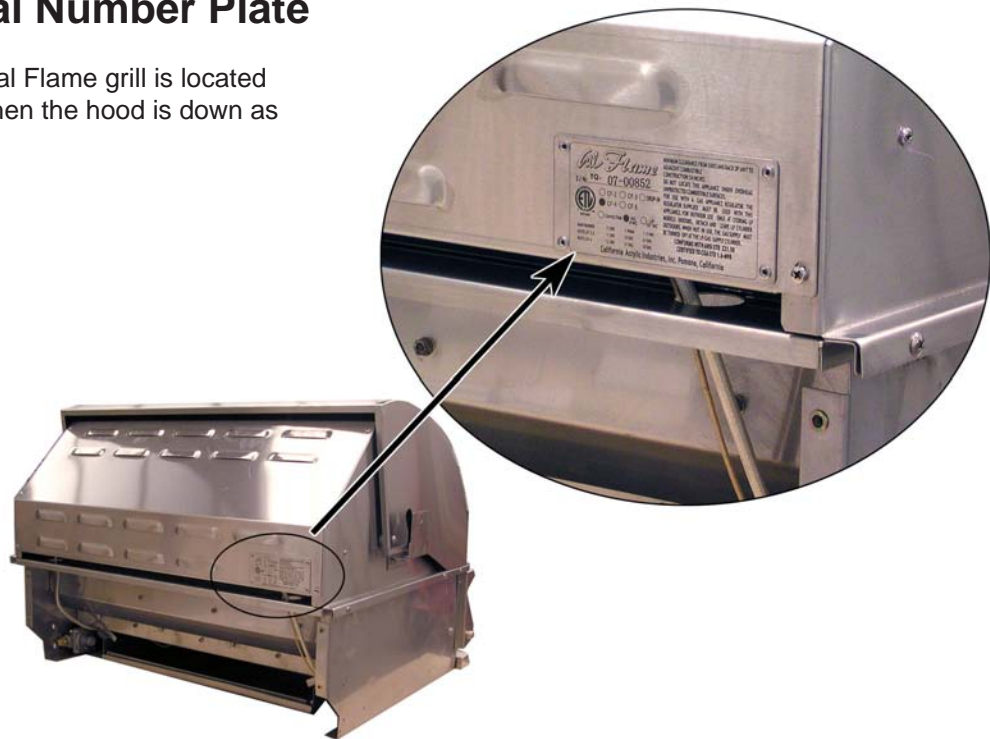

2007 WARRANTY

California Acrylic Industries (C.A.I.) offers the following limited warranties against defects in material and workmanship on Cal Flame barbecue products and components:

Lifetime Equipment Warranty	Lifetime Structural Warranty	Lifetime Component Warranty	Warranty
C.A.I. warrants against deterioration and corrosion	C.A.I. warrants the structural frame to maintain its integrity.	C.A.I. warrants against deterioration and corrosion	C.A.I. warrants the decorative finishes at time of delivery, including:
* Flame Tamers - Stainless Steel * Burners - Cast Stainless Steel * Grates - Stainless Steel * Griddle	* Frame - Lightweight, Durable Galvanized Steel	* Rotisserie - HD Stainless Steel * Mountings - Stainless Steel * Grill Lid and Body - Stainless Steel * Flat Drop-In Body * Charcoal Grill	* Stucco * Grout * Brick * Rock * Tile * Waterfall * Granite * Foot Rest * Warming Drawer * Umbrella * Umbrella Lights

C.A.I. warrants the cart's structural frame, all non-stainless steel fasteners, rotisserie motor, temperature gauge, plastic items, stainless steel drawers, doors, sinks, warming racks, ignitors, tube stainless steel burners, gas valves, food warmer, sear zone, infrared burners, cocktail center, modules, and ice chest for a period of one year.

Extent of Warranty

This 2007 Cal Flame Warranty is only valid on Cal Flame models delivered in the United States or Canada and extends through the selling dealer to the original purchaser at the original site of installation. This warranty becomes valid at time of purchase and ends either by specified time-frame listed above or upon owner transfer or relocation.

Manufacturer Warranty

All Cal Flame models are manufactured with the highest quality appliances and are warranted to be free from defects in material and workmanship at time of delivery. The appliance warranty is extended through the manufacturer of the product. These items include, but are not limited to, the following: Stereos, speakers, refrigerators, keg refrigerators, accessories, televisions, and DVD players.

Warranty Performance

In the event of a malfunction or defect covered under the terms of this warranty, a factory authorized service agent of C.A.I. will perform the necessary repairs. To obtain service, contact the selling dealer. In the event the consumer is unable to obtain satisfactory customer service from the selling dealer or service agent, written notification must be given to the C.A.I. Customer Relations Department within 10 days of the reported failure. There will be no charge for parts or labor on a covered item. However, the service agent may assess a reasonable travel or mileage charge per service call. If C.A.I. determines that repair of a covered item is not feasible, C.A.I. reserves the right to replace the defective merchandise with merchandise equal in value to the original purchase price. Warranty repair and / or replacement is the sole discretion of C.A.I. and this warranty does not cover costs therein, including but not limited to: freight, removal, re-installation, etc. This warrant is non-transferable and may not be extended beyond the above mentioned time frames under any circumstances, by any of C.A.I.'s representatives.

Warranty Limitations

This warranty is void if the barbecue grill, cart or island has been subject to negligence, alteration, misuse, repairs, dings, dents, scratches, or incorrect and / or prohibited applications, as specified in the Owner's Manual. Gas lines must be installed by a licensed plumber only or local gas company agent. Incorrect electrical installation by unlicensed electricians, service by non-C.A.I. authorized representatives, acts of God and other cases beyond the control of C.A.I. are not covered by this warranty. Please refer to the Owner's Manual for examples of exclusions and common acts invalidating this warranty. This limited warranty applies only to barbecue grills, carts, and islands used for personal, family, and outdoor household purposes. This warranty does not apply to labor charges on grills, replacement parts and hardware. This limitation is retroactive and applies to all grills and hardware manufactured from 2000 and hereafter.

Disclaimers

C.A.I. shall not be liable for loss of use of the barbecue grills, carts, islands or other incidental or consequential costs, expense or damages, which may include, but are not limited to, removal of permanent deck or other custom fixtures or the necessity for crane removal. Any implied warranty shall have duration equal of the applicable warranty stated above.

Natural stone: Rock, travertine, marble, granite, etc. may be characterized by dry seams, pits, chips, cracks, and fossils that are often filled with grout during installation. These are normal imperfections and are not considered defects.

Legal Remedies

This limited warranty gives you specific legal rights. You may have other rights, which may vary from state to state.

Customer Service

For customer service, contact the authorized selling dealer immediately. If you need additional information or assistance, please contact the C.A.I. Customer Relations Department at 1462 E. Ninth St., Pomona CA 91766 or call (800) 225-7727.



Warranty Information

See your Cal Flame barbecue dealer for a copy of the applicable warranty, details and any questions you may have regarding the warranty coverage on your barbecue.

Warranty Limitations

The Limited Warranty is void if the barbecue has been subject to negligence, alteration, misuse, abuse, repairs by non- C.A.I. authorized representatives, incorrect electrical installation, acts of God and any other cases beyond the control of C.A.I. Examples of common acts invalidating this warranty include but are not limited to:

- Scratches caused by normal use.
- Damage caused by extreme weather conditions (hot, cold, etc.)
- Damage caused by dirt, sand, and/or water damage.

- Damage caused by continued operation of the barbecue with either known or unknown problems.
- Damage caused by direct sunlight.
- Damage caused as a result of failure to follow the operating instructions as defined in this Owner's Manual.

This Limited Warranty applies only to barbecues normally used for personal, family, or household purposes.

This Limited Warranty specifically excludes commercial barbecues.

Warranty Exclusions

C.A.I. warrants the barbecues from defects in material and workmanship for a period of one year from the original date of purchase.

Barbecue stereo systems are delivered with their own manufacturer's warranty. For more information, see their warranties in the owner's information package that was delivered with your barbecue.

Don't forget to register your new product at www.calspas.com.

Locating the product serial number

The serial number of your Cal Flame grill is located on the back and is visible when the hood is down (see page 24). You will need this number to properly register your grill or cart and activate coverage. Write this information in the space provided below.

Grill or cart model: _____

Grill or cart serial number: _____

Type of fuel (circle one): Liquid propane Natural gas Charcoal

Date purchased: _____

Date installed: _____

Cal Flame dealer's phone number: _____

Cal Flame dealer's address: _____